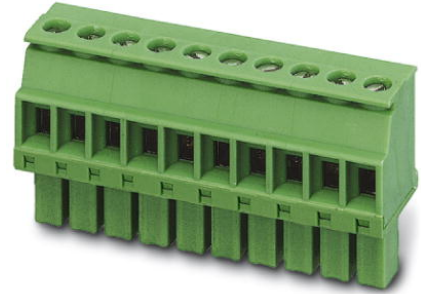

## MCVW 1,5/15-ST-3,81

Order No.: 1827101

The figure shows a 10-position version of the product

<http://eshop.phoenixcontact.de/phoenix/treeViewClick.do?UID=1827101>

Plug component, nominal current: 8 A, rated voltage: 160 V, pitch:  
3.81 mm, no. of positions: 15, type of connection: Screw connection

### Commercial data

EAN	4017918114282
Pack	50 Pcs.
Customs tariff	85366990
Weight/Piece	0.01177 KG
Catalog page information	Page 129 (CC-2007)

### Product notes

WEEE/RoHS-compliant since:  
01/01/2003

<http://www.download.phoenixcontact.com>  
Please note that the data given here has been taken from the online catalog. For comprehensive information and data, please refer to the user documentation. The General Terms and Conditions of Use apply to Internet downloads.

### Technical data

#### Dimensions / positions

Height	12.5 mm
Pitch	3.81 mm
Dimension a	53.34 mm
Number of positions	15
Screw thread	M 2

Tightening torque, min	0.22 Nm
<b>Technical data</b>	
Insulating material group	I
Rated surge voltage (III/3)	2.5 kV
Rated surge voltage (III/2)	2.5 kV
Rated surge voltage (II/2)	2.5 kV
Rated voltage (III/2)	160 V
Rated voltage (II/2)	320 V
Connection in acc. with standard	EN-VDE
Nominal current $I_N$	8 A
Nominal voltage $U_N$	160 V
Nominal cross section	1.5 mm <sup>2</sup>
Maximum load current	8 A (with 1.5 mm <sup>2</sup> conductor cross section)
Insulating material	PA
Inflammability class acc. to UL 94	V0
Internal cylindrical gage	A1
Stripping length	7 mm

<b>Connection data</b>	
Conductor cross section solid min.	0.14 mm <sup>2</sup>
Conductor cross section solid max.	1.5 mm <sup>2</sup>
Conductor cross section stranded min.	0.14 mm <sup>2</sup>
Conductor cross section stranded max.	1.5 mm <sup>2</sup>
Conductor cross section stranded, with ferrule without plastic sleeve min.	0.25 mm <sup>2</sup>
Conductor cross section stranded, with ferrule without plastic sleeve max.	1.5 mm <sup>2</sup>
Conductor cross section stranded, with ferrule with plastic sleeve min.	0.25 mm <sup>2</sup>
Conductor cross section stranded, with ferrule with plastic sleeve max.	0.5 mm <sup>2</sup>
Conductor cross section AWG/kcmil min.	28
Conductor cross section AWG/kcmil max	16
2 conductors with same cross section, solid min.	0.08 mm <sup>2</sup>
2 conductors with same cross section, solid max.	0.5 mm <sup>2</sup>

2 conductors with same cross section, stranded min.	0.08 mm <sup>2</sup>
2 conductors with same cross section, stranded max.	0.75 mm <sup>2</sup>
2 conductors with same cross section, stranded, ferrules without plastic sleeve, min.	0.25 mm <sup>2</sup>
2 conductors with same cross section, stranded, ferrules without plastic sleeve, max.	0.34 mm <sup>2</sup>
2 conductors with same cross section, stranded, TWIN ferrules with plastic sleeve, min.	0.5 mm <sup>2</sup>
2 conductors with same cross section, stranded, TWIN ferrules with plastic sleeve, max.	0.5 mm <sup>2</sup>

### Certificates / Approvals



#### CSA

Nominal voltage U <sub>N</sub>	300 V
Nominal current I <sub>N</sub>	8 A
AWG/kcmil	28-16

#### CUL

Nominal voltage U <sub>N</sub>	300 V
Nominal current I <sub>N</sub>	8 A
AWG/kcmil	30-14

#### UL

Nominal voltage U <sub>N</sub>	300 V
Nominal current I <sub>N</sub>	8 A
AWG/kcmil	30-14
Certification	CB, CSA, CUL, GOST, UL, VDE-PZI

### Accessories

Item	Designation	Description
1051993	B-STIFT	Marker pen, for manual labeling of unprinted Zack strips, smear-proof and waterproof, line thickness 0.5 mm

0804109	SK 3,81/2,8:FORTL.ZAHLEN	Marker card, printed horizontally, self-adhesive, 10-section marker strip, 14 identical decades marked 1-10, 11-20 etc. up to 91-(99)100, sufficient for 140 terminal blocks
0805056	SK 3,81/2,8:SO	Marker card, special printing, self-adhesive, labeled acc. to customer requirements, 14 identical marker strips per card, max. 25-position labeling per strip, color: White
0803883	SK U/2,8 WH:UNBEDRUCKT	Unprinted marker cards, DIN A4 format, pitch as desired, self-adhesive, with 50 stamped marker strips, 185 mm strip length, can be labeled with the CMS system or manually with the M-PEN

**Tools**

1205037	SZS 0,4X2,5	Screwdriver, bladed, matches all screw terminal blocks up to 1.5 mm <sup>2</sup> connection cross section, blade: 0.4 x 2.5 mm
---------	-------------	--

**Additional products**

Item	Designation	Description
<b>General</b>		
1897937	EMC 1,5/15-G-3,81	Header, nominal current: 8 A, rated voltage: 160 V, pitch: 3.81 mm, no. of positions: 15, mounting: press in
1860773	EMCV 1,5/15-G-3,81	Header, nominal current: 8 A, rated voltage: 160 V, pitch: 3.81 mm, no. of positions: 15, mounting: press in
1858015	IMC 1,5/15-ST-3,81	Plug component, nominal current: 8 A, rated voltage: 160 V, pitch: 3.81 mm, no. of positions: 15, type of connection: Screw connection
1803400	MC 1,5/15-G-3,81	Header, nominal current: 8 A, rated voltage: 160 V, pitch: 3.81 mm, no. of positions: 15, mounting: Soldering
1830088	MCD 1,5/15-G-3,81	Header, nominal current: 8 A, rated voltage: 160 V, pitch: 3.81 mm, no. of positions: 15, mounting: Soldering
1843208	MCD 1,5/15-G1-3,81	Header, nominal current: 8 A, rated voltage: 160 V, pitch: 3.81 mm, no. of positions: 15, mounting: Soldering
1830538	MCDV 1,5/15-G-3,81	Header, nominal current: 8 A, rated voltage: 160 V, pitch: 3.81 mm, no. of positions: 15, mounting: Soldering
1847864	MCDV 1,5/15-G1-3,81	Header, nominal current: 8 A, rated voltage: 160 V, pitch: 3.81 mm, no. of positions: 15, mounting: Soldering
1803552	MCV 1,5/15-G-3,81	Header, nominal current: 8 A, rated voltage: 160 V, pitch: 3.81 mm, no. of positions: 15, mounting: Soldering
1837560	MCVDU 1,5/15-G-3,81	Header, nominal current: 8 A, rated voltage: 160 V, pitch: 3.81 mm, no. of positions: 15, mounting: Soldering
1832866	MCVK 1,5/15-G-3,81	Header, nominal current: 8 A, rated voltage: 160 V, pitch: 3.81 mm, no. of positions: 15, mounting: Mounting rail
1827402	SMC 1,5/15-G-3,81	Header, nominal current: 8 A, rated voltage: 160 V, pitch: 3.81 mm, no. of positions: 15, mounting: Soldering

## Drawings

### Dimensioned drawing

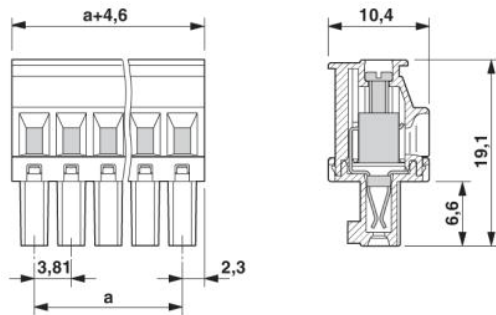

**Address**

PHOENIX CONTACT GmbH & Co. KG  
Flachmarktstr. 8  
32825 Blomberg, Germany  
Phone +49 5235 3 00  
Fax +49 5235 3 41200  
<http://www.phoenixcontact.de>



© 2008 Phoenix Contact  
Technical modifications reserved;